

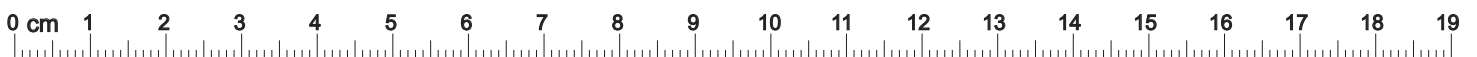

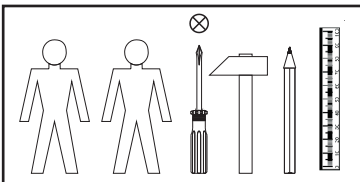











A	B	C	D
1	S171-002	1069x376	1/1
2	S171-105	1075x346	1/1
3	S171-106	1075x346	1/1
4	S171-202	791x350	1/1
5	S171-204	791x350	1/1
6	S171-302A	757x309	1/1
7	S171-903	1089x771	1/1



2x  c328	4x  K16 a1	4x  φ7x50 mm e1	8x  φ5 d1	8x  φ8x30 mm f1
4x  φ4x30 mm p9	4x  b1	4x  56x56/20 mm k52	8x  φ4x30 mm p21	4x  φ15x12mm #16 r1
6x  I2	4x  r42	4x  ø16 s2	1x  z1	

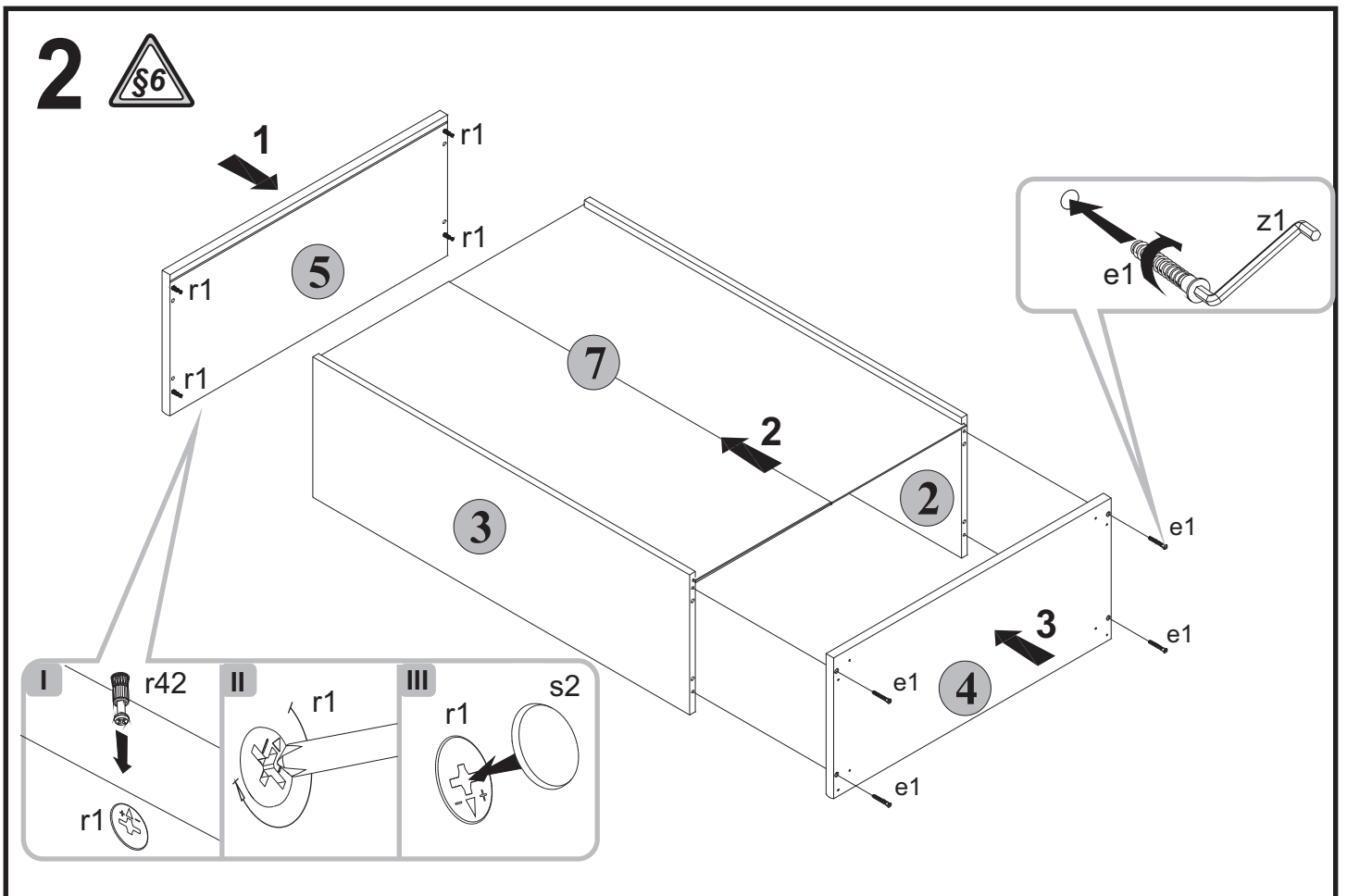
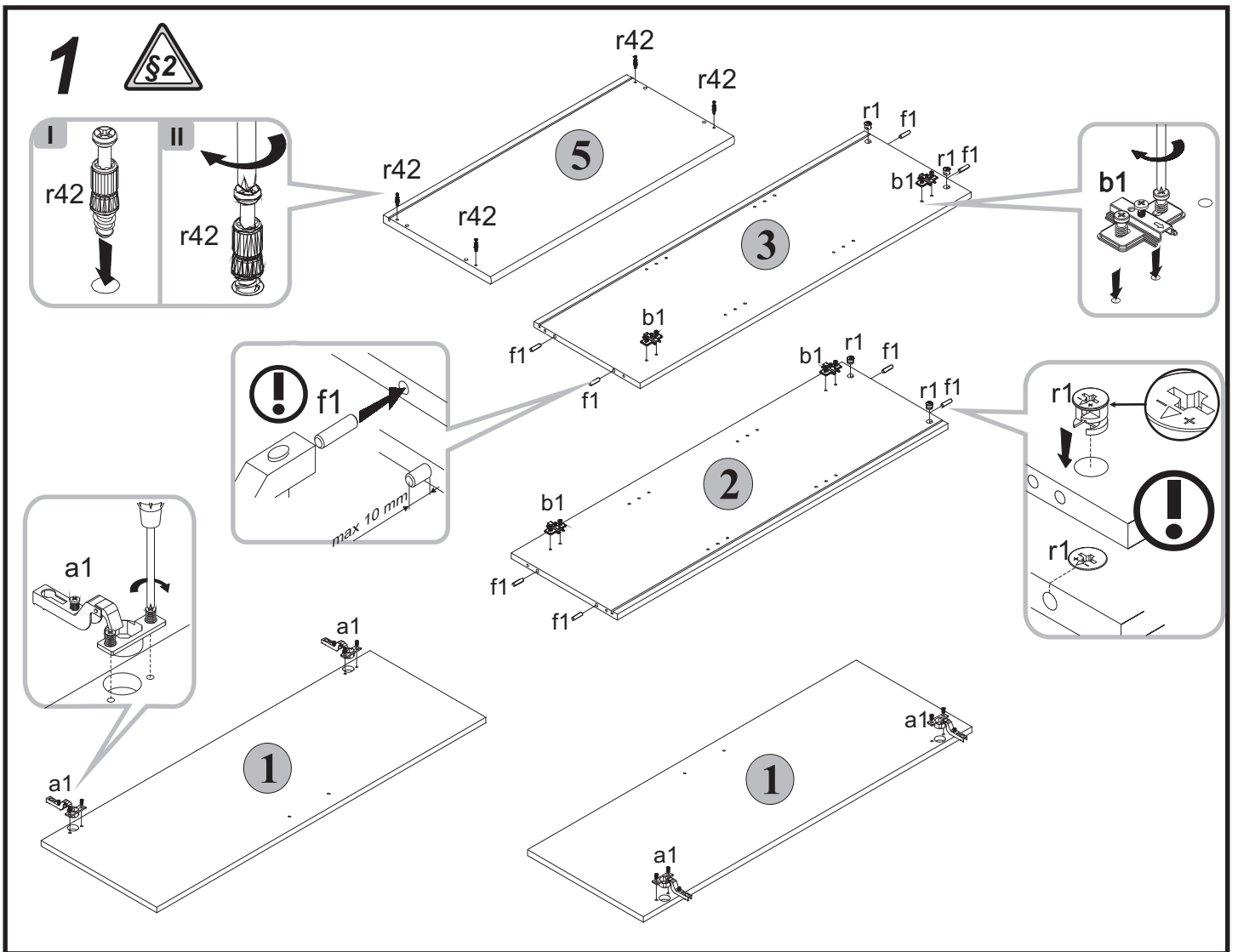

3

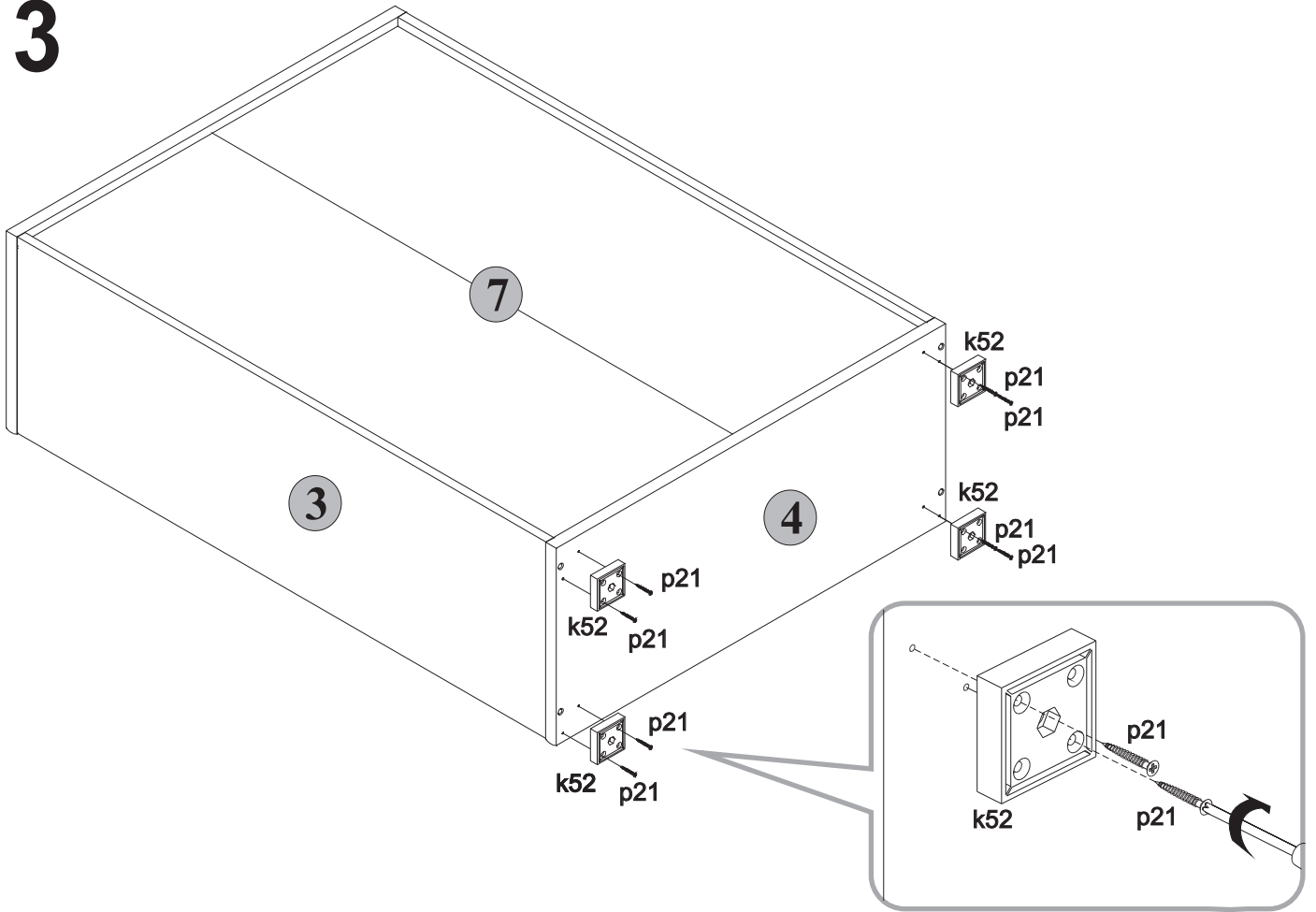

4

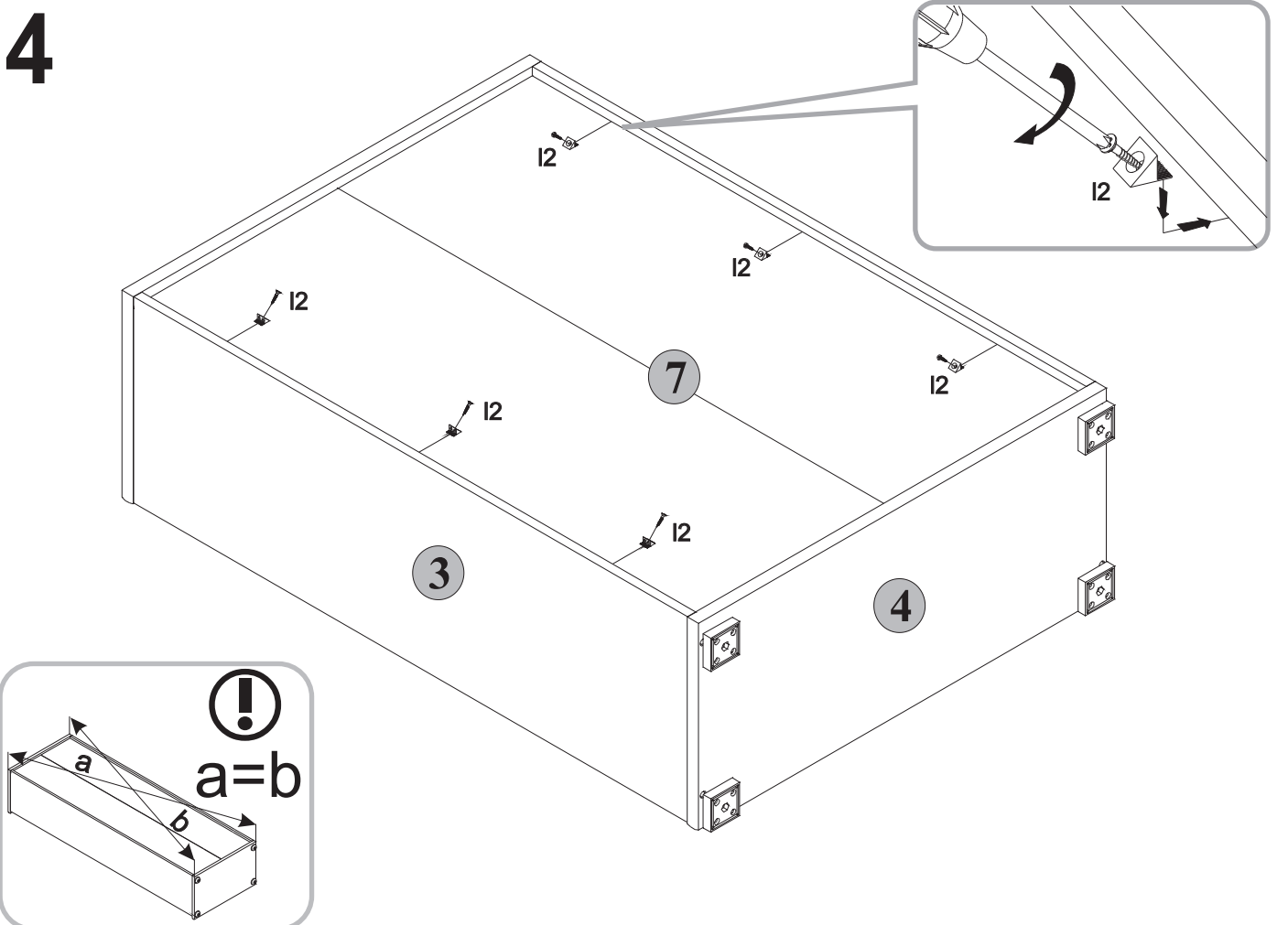

5

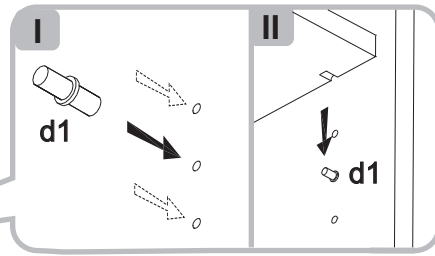
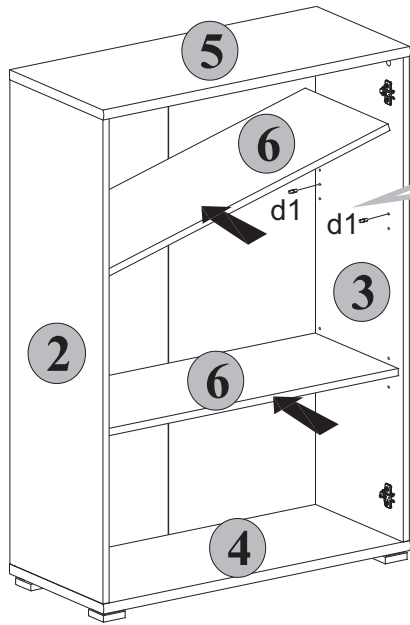

6

